



半导体材料与器件科学云讲堂

——纳米材料及纳米电子器件IV和CV测试

主讲人：林彩霞——半导体领域测试专家

2020/4/29

半导体材料与器件科学云讲堂

- ✓ 专业测试平台
- ✓ 六大类测试流程
- ✓ 剖析、解决半导体新问题



关注“泰克科技”公众号



每月2期专题直播，等您解锁！

直播日程

第一季 直播课程 (4~6月)

- 纳米材料及纳米电子器件IV和CV测试 4月29日
- 二维材料/石墨烯及其电子器件IV和CV测试 5月15日
- 量子材料及超导材料电输运物性表征测试 5月29日
- 超快脉冲在先进的NVM测试中的应用及神经元网络测试前瞻 6月

番外篇一

测试技巧: 半导体参数测试仪使用技巧及案例集锦 6月

第二季 直播课程 (7~9月)

- 宽禁带半导体(GaN/SiC)材料及器件测试
- 功率IGBT器件测试系统及自动化简介
- 微机电系统MEMS测试概述
- MOSFET的准静态CV/超低频CV测试
- 半导体器件可靠性HCI/NBTI测试

番外篇二

测试技巧: 快速上手自动化半导体参数测试系统



加入“泰克半导体直播讨论群”
只要你问，只要我有



纳米材料及纳米电子器件IV和CV测试 日程

14: 30 - 15: 00	<p>纳米材料及纳米电子器件的研究与应用前景</p> <ul style="list-style-type: none">• 纳米材料的特性• 纳米多种器件• 纳米材料电学性能测试 <p>泰克纳米线/碳纳米管及其电子器件的测试</p> <ul style="list-style-type: none">• 超小电流测试如何解决?• 纳米材料在不同领域的测试如何配置?• 对于研发和产线的纳米测试, 如何配置测试流程?
15: 00 - 15: 30	互动答疑
15: 30 - 15: 45	抢答有奖

抢答有奖思考题:

1. 对于纳米材料的超小电流一般到多少?
2. 对于以上超小电流选用什么仪器可测到?
3. 一维纳米材料的典型代表是什么?

Tektronix

纳米材料及纳米器件的研究和应用前景

林彩霞

29 APRIL 2020



纳米材料

- 三维空间尺度至少有一维处于纳米量级(1-100nm)的材料
 - 是由尺寸介于原子、分子和宏观体系之间的纳米粒子所组成的新一代材料。

• 纳米材料的分类

◦ 按结构

- 零维材料 – 量子点, 纳米粉末, 纳米颗粒
- 一维材料 – 纳米线或纳米管
- 二维材料 – 纳米薄膜, 石墨烯
- 三维测量 - 纳米固体材料

◦ 按组成

- 金属纳米材料
- 半导体纳米材料
- 有机高分子纳米材料
- 复合纳米材料

◦ 按物理性质

- 见右图

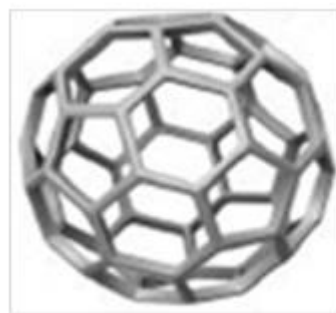

零维富勒烯



一维碳纳米管

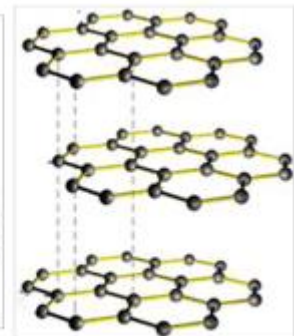

三维石墨烯

二维材料：后期会有专门的直播课程，5月15日。



系列		类别			
		第1系列	第2系列	第3系列	第4系列
类别	多层状				
	杆状				
	等轴晶状				

图 1-4 纳米材料的分类

(图中第1系列和第2系列较薄的层状和黑色部分表明晶界；第3系列的黑点表明晶界的不同成分；第4系列较黑线组成部分表明分散在基体中不同成分的晶体)

纳米材料的特性

- 基本特性【与宏体材料不同】

- 表面与界面效应
 - 熔点降低比
 - 热增大
- 小尺寸效应
 - 导体变得不能导电；绝缘体却开始导电。
 - 超硬
- 量子尺寸效应
- 宏观量子隧道效应

- 理化性能

- 高强度、高韧性
- 高比热和热膨胀系数
- 异常电导率和扩散率
- 高磁化率

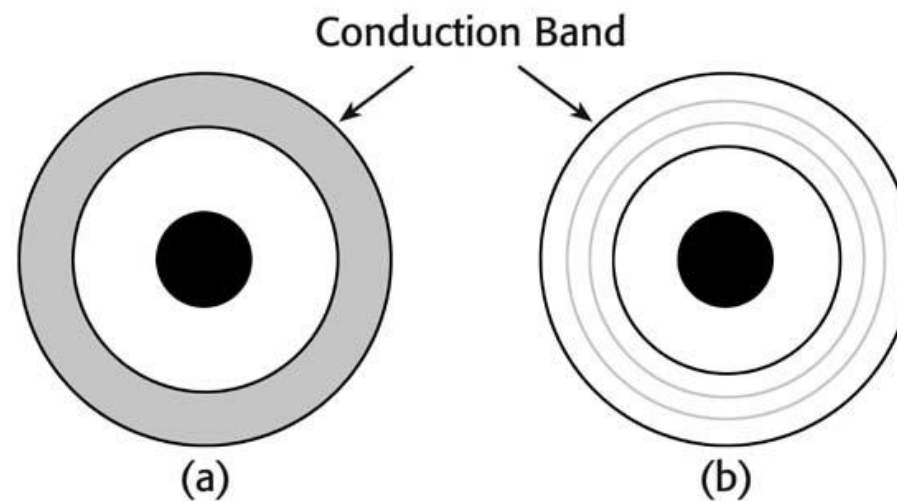
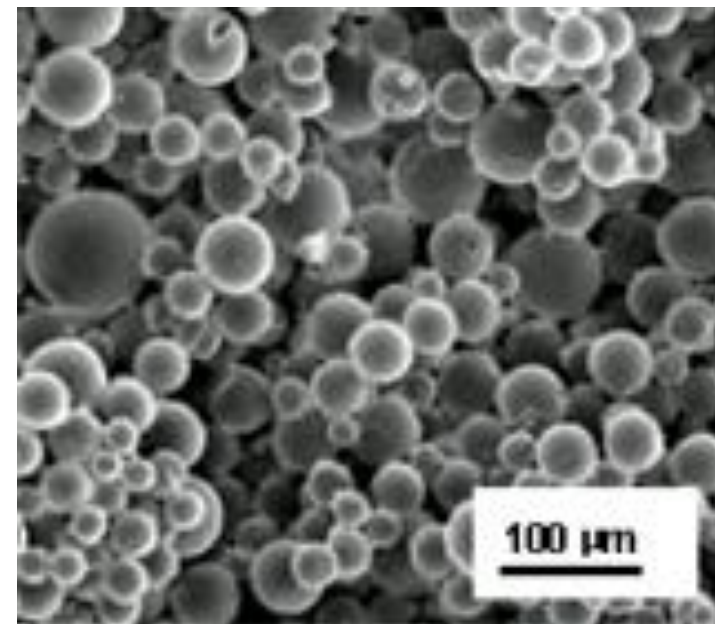
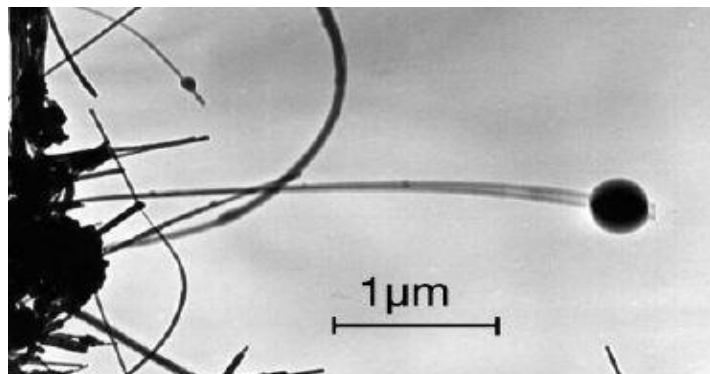

碳纳米管

- 又名巴基管，碳的同素异形体，是一种具有特殊结构的一维量子材料。

按石墨层数分类

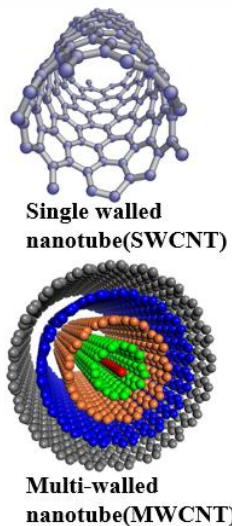

按手性分类(single walled)

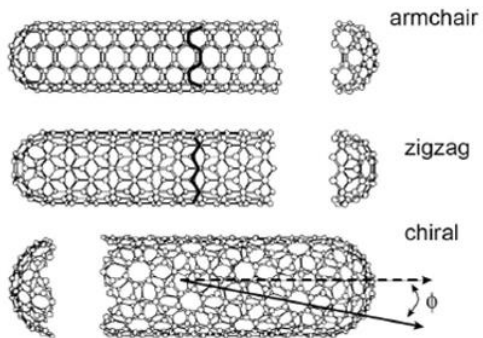

按排列状况分类

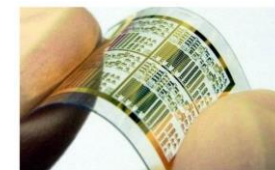
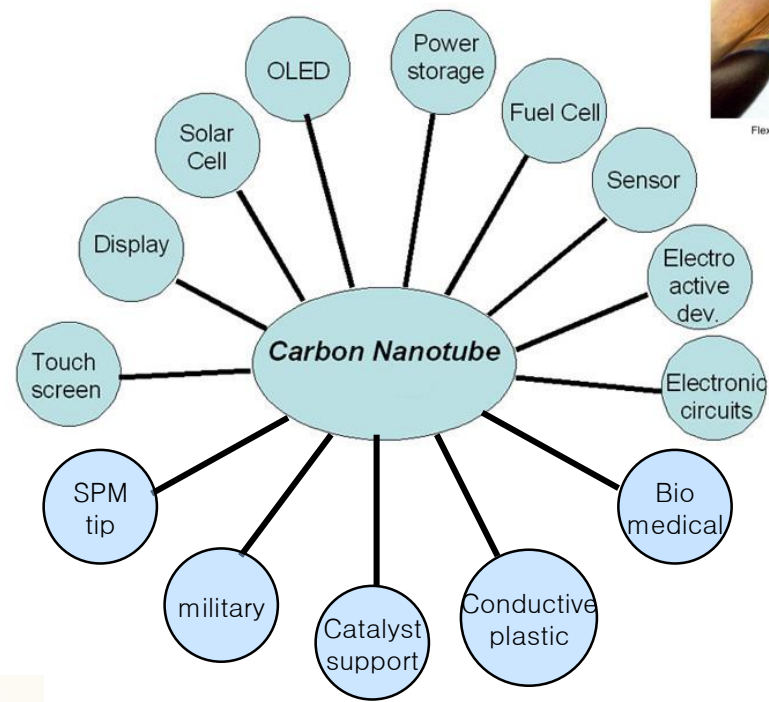
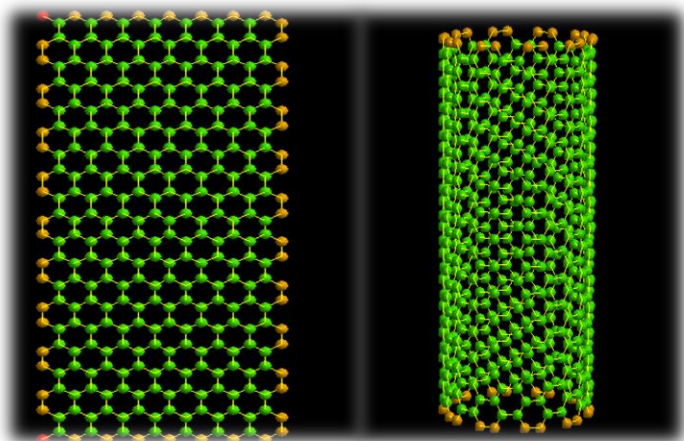
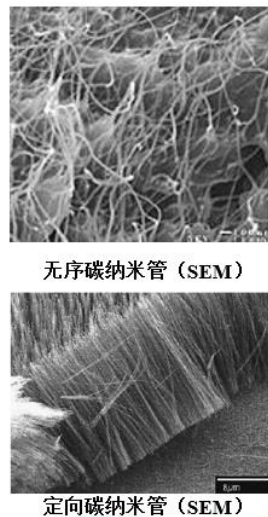

Flexible carbon nanotube integrated circuits

碳纳米管的性质

热学性能

碳纳米管具有良好的**传热性能**，由于是一维材料，其在径向上的导热性能优越，我们甚至可以在**复合材料中掺杂**微量的碳纳米管，使得复合材料的热导率得到很大的改



电学性能

碳纳米管在电学性能上也有很大的**发展空间**。

实验表明不同类型的碳纳米管，导电性能也不相同，例如，单壁纳米管总是**金属性**的，手性形纳米管中则部分为半导体性，部分为金属性的。

有报道说Huang通过计算认为直径为0.7nm的碳纳米管具有超导性，尽管其超导转变温度只有 $1.5 \times 10^{-4} \text{K}$ ，但是预示着碳纳米管在**超导领域**的应用前景。

电特性与管径有较大关系

- $d > 6 \text{nm}$ 导电性明显下降
- $d < 6 \text{nm}$ 优良的导电性
- $d \sim 0.7 \text{nm}$ 表现出超导性

□ 电阻率 $0.05 \mu\Omega \cdot \text{m} \sim 10 \text{m}\Omega \cdot \text{m}$

□ 电流密度 $10^{10} \sim 10^{13} \text{A/m}^2$

力学性能

金刚石是我们所知道的自然界中最为坚硬的物质。而作为金刚石的同素异形体，碳纳米管具有良好的力学性能。

硬度：碳-碳共价键是自然界中最稳定的化学键，而碳纳米管的强度接近于碳-碳键的强度，因此单壁碳纳米管的抗拉强度达到50~200GPa，杨氏模量与金刚石相当，强度是钢的100倍。

弹性：与金刚石的三维结构不同，碳纳米管作为一维纳米材料可弯可拉具有**相当好的弹性**。实验表明碳纳米管在拉升达原来长度的136%时仍然可以恢复到原来的样子。而且即使受到了很大的外加应力，碳纳米管也不会发生脆性断裂。

其他性能

碳纳米管还具有**光学和毛细**，化学等其他良好的性能，也正是这些特性使得碳纳米管成为许多新材料的基础。

储氢性能

碳纳米管具有比较大的表面积，且具有**大量的微孔**，其储氢量远远大于传统材料的储氢量，因此被认为是良好的存储材料。

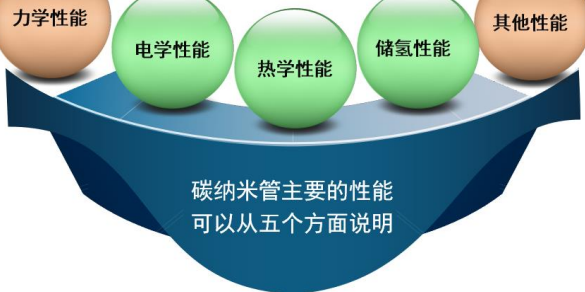

纳米材料表征方法的分类

- 成分分析
 - 材料的组成元素及其含量
- 颗粒分析
 - 颗粒形状、粒度、粒度分布、颗粒结晶结构
- 结构分析
 - 材料结晶结构、物相组成、组分之间的界面、物相形态
- 性能分析：
 - 物理性能（电、磁、声、光等性能）
 - 化学性能（化学反应性、反应能力、化学性质等）
- 分析方法
 - 以电镜分析为主
 - 扫描隧道电镜 (SMT)有优势
 - 适用于导体和半导体

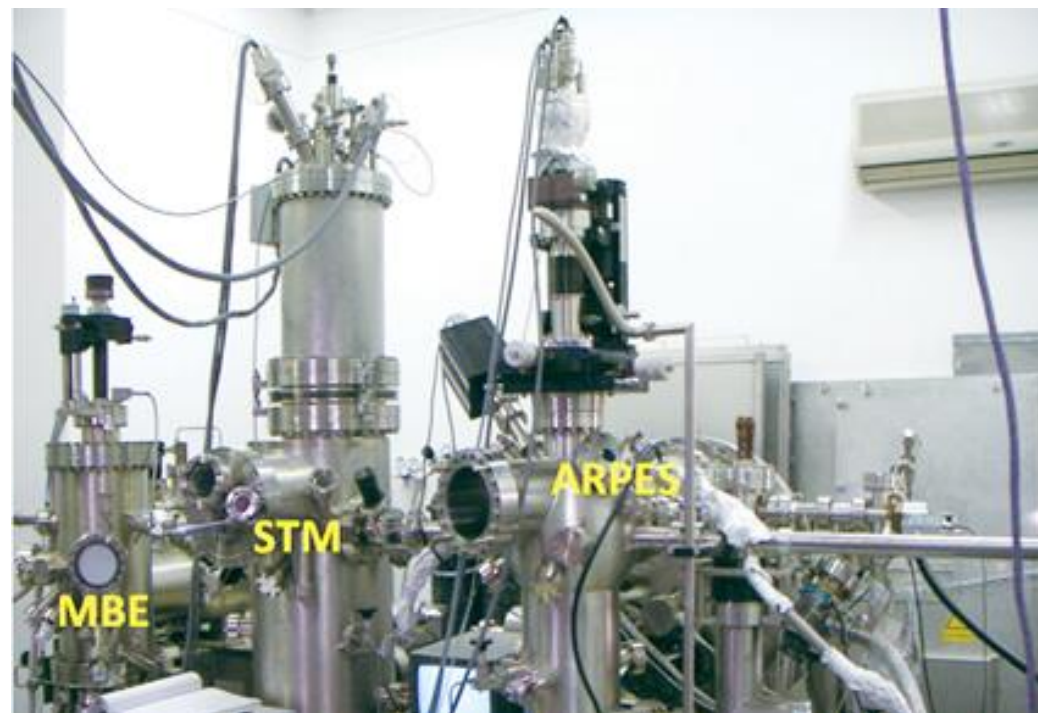

Classification	Particle Size
Macroscopic	>300nm
Mesoscopic	Varies with phase coherence length
Nanoscopic	0.5 – 200nm
Atomic	<0.5nm

纳米材料电学性能测试

态密度测试 (DENSITY OF STATE)

- 态密度表示单位能量范围内所允许的电子数,也就是说电子在某一能量范围的分布情况

- 态密度是微观量, 适合解释纳米粒子尺寸变化引起的特性

$$\rho(E) = \frac{dn_s}{dE} = \frac{4\pi(2m)^{3/2}}{h^3} \sqrt{E}$$

- X 射线光谱 (X-Ray Spectroscopy) 测试

- 或电性能直接测试

- 扫描隧道电镜

- 用微分电导 (di/dv) 随电压曲线得到
 - 高阻接触
 - 低电平 AC 信号调制于静态电流

- SMU + 纳米探针台

- 低阻接触
- 可根据被测样品的阻抗改变SMU工作模式
- 电阻, 电阻率, 霍尔效应测试
- 更适合纳米电子器件

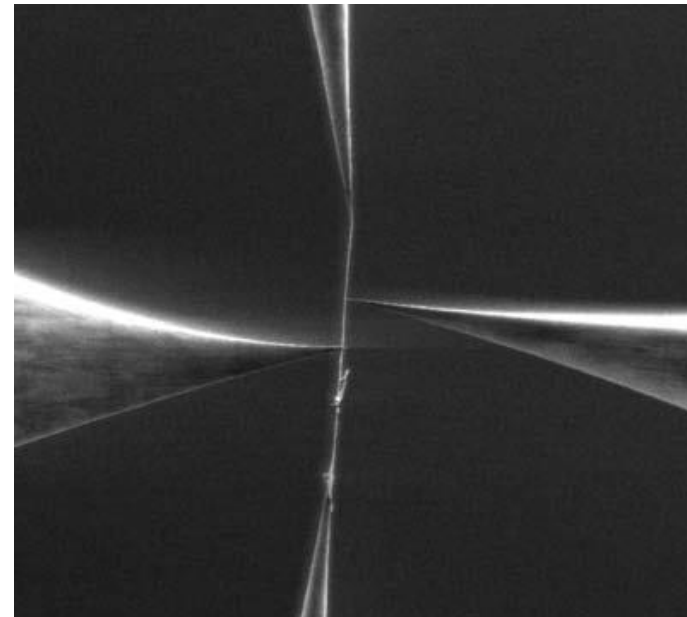

碳纳米管及其构建的多种器件电性能测试

碳纳米管电子器件

- 碳纳米管场发射器
- 碳纳米管 FET
- 单电子晶体管
- 碳纳米管传感器
- 碳纳米管存储器
- 碳纳米管开关
- 碳纳米管集成电路
- 碳纳米管计算机

I-V 测试是最基本的电性能测试

- SMU 是基本测试仪器
- 不同种类的碳纳米管需不同的 SMU 进行测试
 - 选择依据
 - 电阻范围, 电流范围, 电压范围
 - 通道数
 - 脉冲需求
 - 电容测试需求

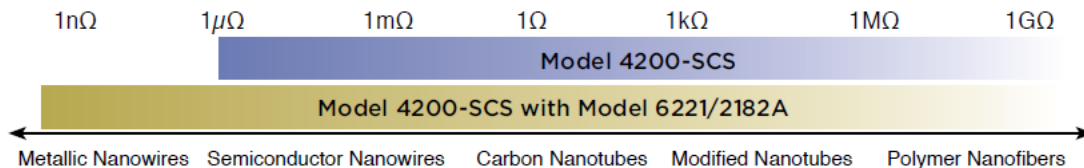
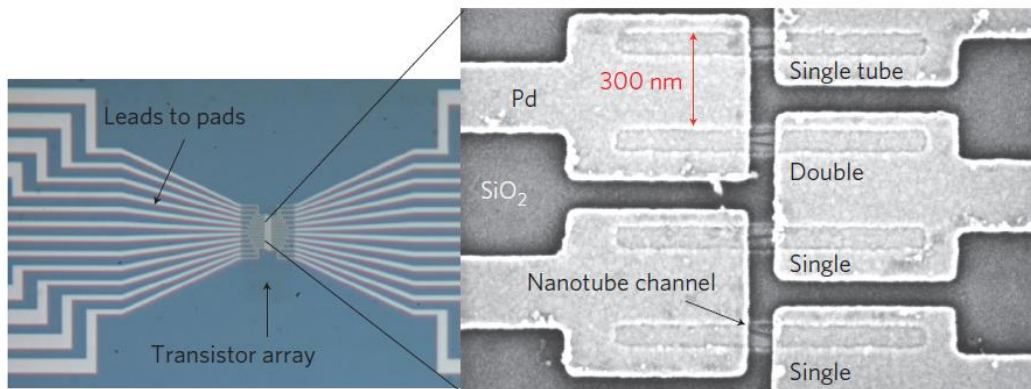
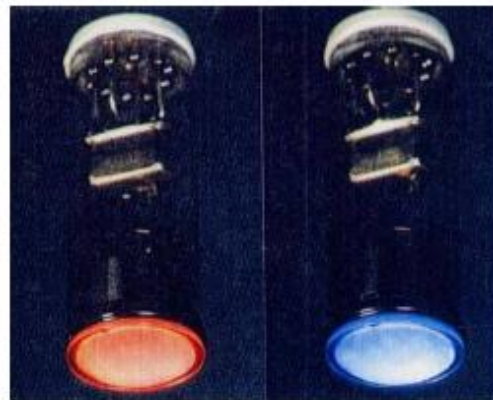
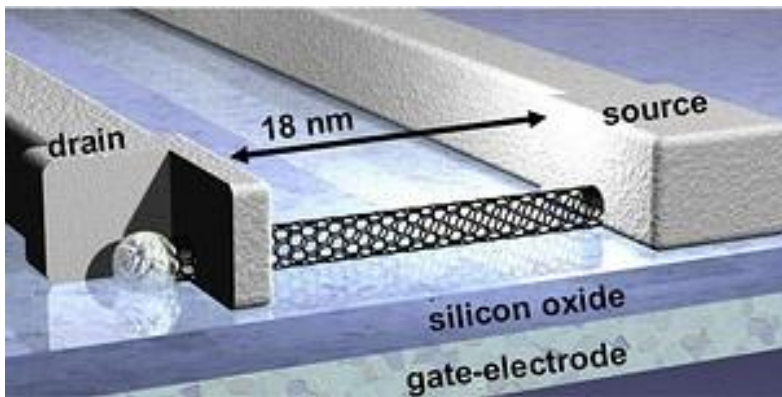

Circuit to Measure Drain Family of Curves on a Carbon Nanotube

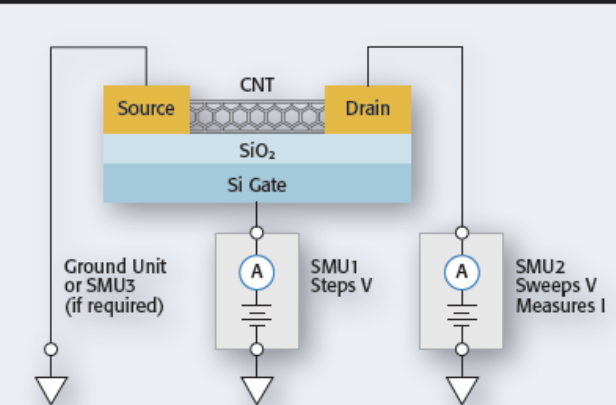

Current vs. Voltage Characteristics of Carbon Nanotube FET

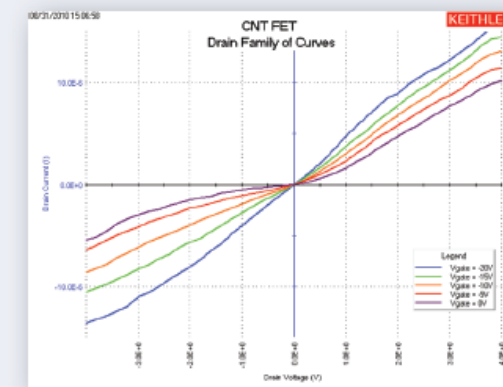

碳纳米管电子器件测试 SMU 选型表见下下页

纳米材料/纳米电子器件电学测试面临的挑战及应对

- 纳米级尺寸

- 性能异于宏尺寸材料与器件
- 状态变化快
 - 对测试仪器响应速度有要求

- 对测试夹具要求高

- 纳米探针台

- 对测试仪器要求高

- 承受即测试电流超小 (达 fA 级)
- 承受及测试电压超低 (达 nV 级)
- 选择与被测纳米材料和器件电性能相适应的 SMU

- 必须防自热

- 需有脉冲模式的 SMU

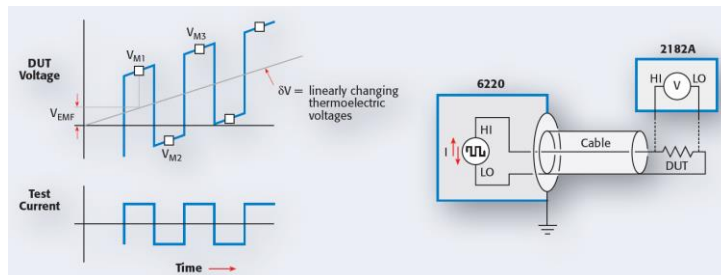
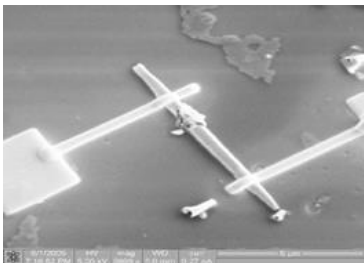

- 需多种降低误差与噪声的手段

- 适当的工作方式
 - 加流测压或加压测流
- 适当的连接方式
- 降低外部噪声的影响
 - 屏蔽与滤波
 - 移除一切可产生噪声的设备
 - 测试直流时, 设置积分时间为供电周期的整数倍
- 降低热电噪声
 - 用相同材质处理连接
 - 降低被测器件温度梯度
 - 测试仪器完全预热
 - 选用 Delta 模式

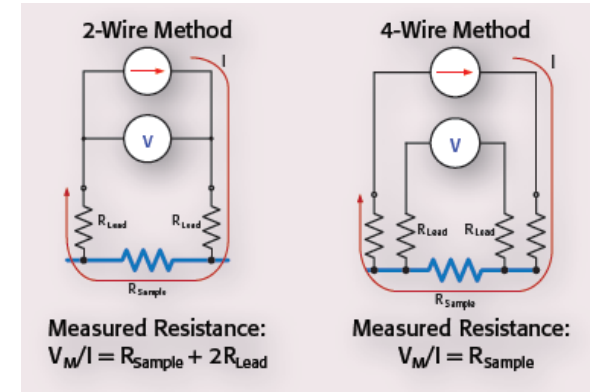
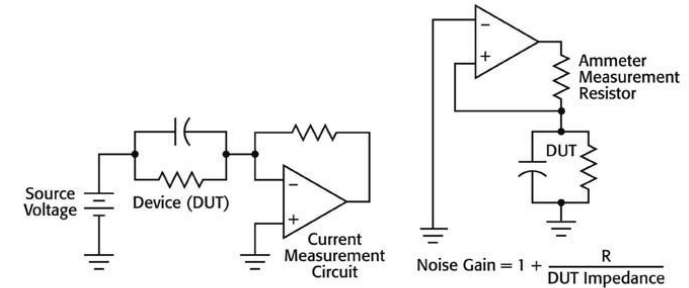

Which Keithley nanotechnology solution is best for your sourcing or measurement application?

Keithley instrumentation is being used in a growing list of nanotechnology research and production test settings. The applications shown here are only a sampling of the nanotechnology test and measurement tasks for which our instruments and systems are suitable. If your tests require sourcing or measuring low level signals, Keithley instrumentation can help you perform them more accurately and cost-effectively.

Want low current measurements without the high price tag?

With $<200\mu\text{V}$ burden voltage, the cost-effective **Model 6485 Picoammeter** ensures accurate low current measurements, even in circuits with very low source voltages. The **Model 6487 Picoammeter/Voltage Source** adds a 500V bias source for high resistance and resistivity measurements. The **Model 6482 Dual-Channel Picoammeter/Voltage Source** gives you two channels in one instrument to save rack space.

Trying to characterize high resistance nanomaterials?

The **Model 6517B Electrometer/High Resistance Meter's** built-in 1kV source, 200T Ω input resistance, and low current sensitivity make it an ideal solution.

Want seamless control over current pulse sourcing and measurement?

When linked together, the **Model 6221 AC+DC Current Source** and **Model 2182A Nanovoltmeter** are designed to operate like a single instrument to make high speed pulse mode measurements.

Studying highly resistive nanowires?

The **Model 6430 Sub-Femtoamp Remote SourceMeter®** instrument's low noise and drift performance make it ideal. It measures currents with 400aA (400x10⁻¹⁸A) sensitivity.

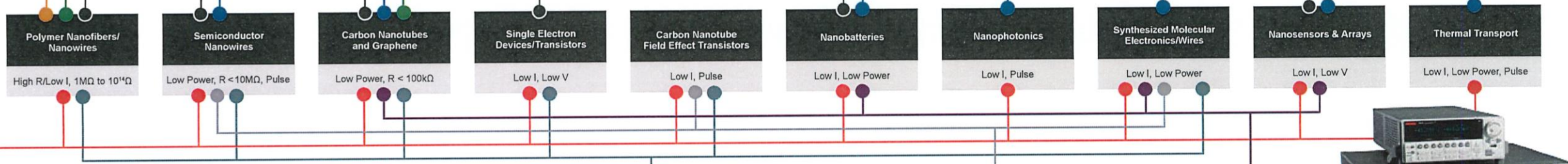

Want multiple channels of sourcing and measurement?

The fully integrated **Model 4200 Semiconductor Characterization System** brings together all three core measurement types, DC-IV, AC impedance and transient I-V, in one easy-to-operate package. It's used in many phases of nano research, development, characterization, and production.

Need to characterize mobility, carrier density, and device speed?

The **Model 4210-CVU Option** takes the guesswork out of obtaining valid capacitance-voltage (C-V) measurements quickly and easily, with intuitive point-and-click setup, complete cabling, and built-in element models.

Troubled by overheating problems?

The **Model 4225-PMU** option for the Model 4200-SCS performs pulsed I-V testing on a variety of devices for many different purposes, including preventing device self-heating by using narrow pulses and/or low duty cycle pulses rather than DC signals.

Testing lots of devices?

Series 2600B System SourceMeter® instruments let you make precision DC, pulse, and low frequency AC source-measure tests quickly, easily, and economically. They offer virtually unlimited flexibility to scale the system's channel count up or down to match changing application needs.

Looking for just a single channel?

Each **Series 2400 SourceMeter instrument** is a complete, single-channel DC parametric tester. Choose from a variety of ranges and functions to suit specific application needs. The Model 2430 can be programmed to produce individual pulses or pulse trains up to 5ms wide.

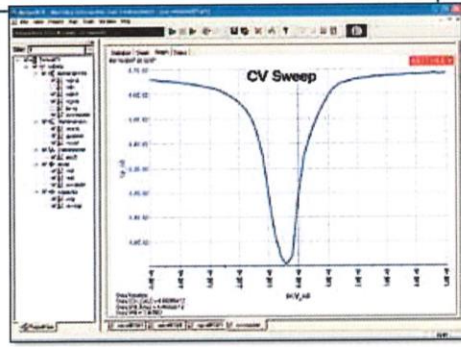

Ask Us Your Application Or Product Question.

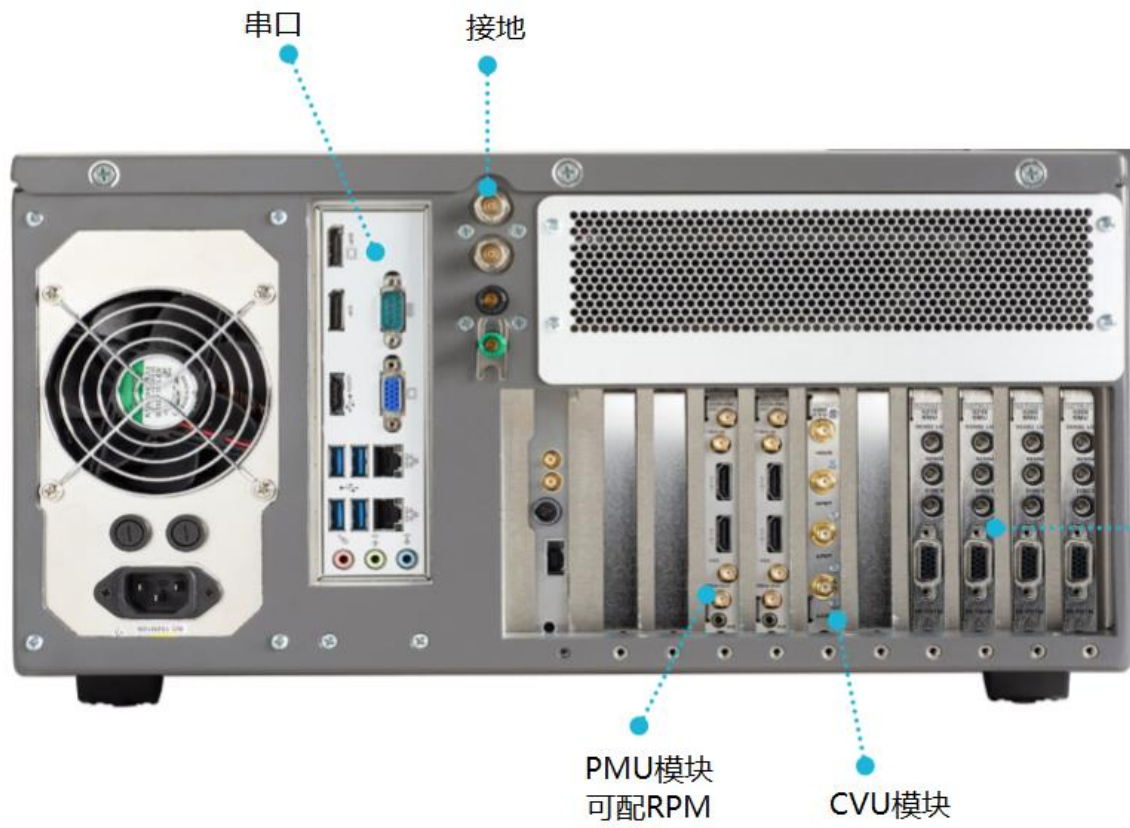

NEW
SMU
MODULES



碳纳米管电子器件电性能综合测试系统

• 硬件:

- 4200A – SCS + 纳米探针台 (第三方)
 - 多插槽, 根据测试项目灵活配置
 - 4210 CVU, 4225 PMU 等

• 软件: Clarius

- 内置多种纳米材料测试模式

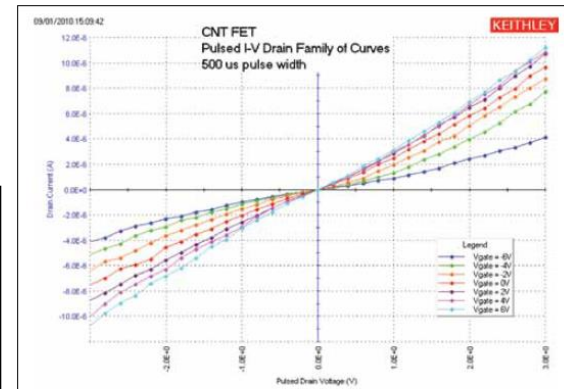
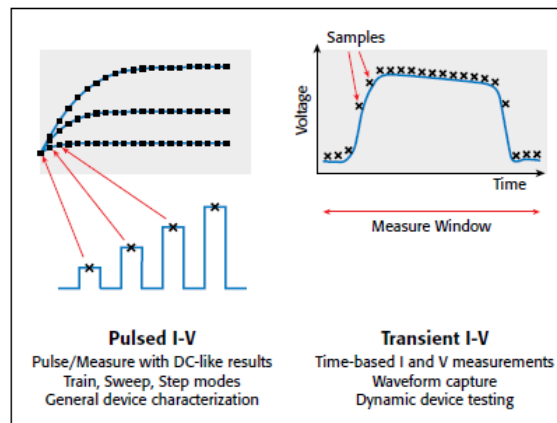
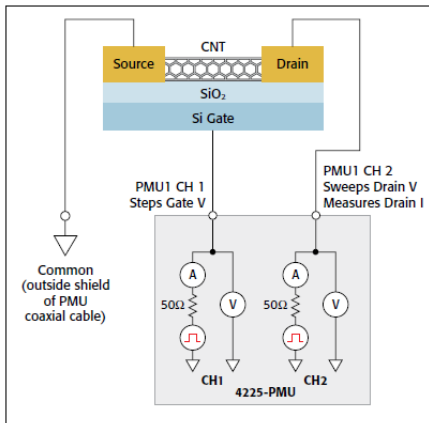

Pulsed I-V drain family of curves of CNT FET

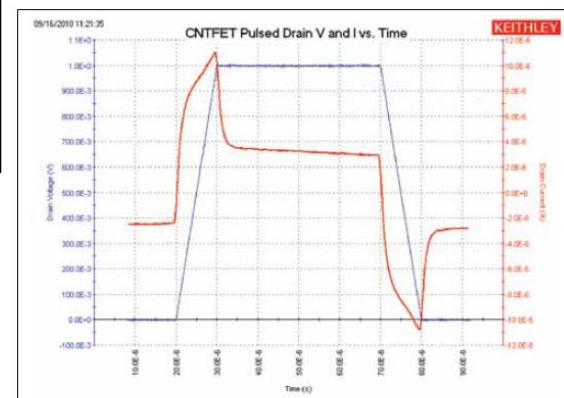

Waveform of single drain voltage pulse and resulting drain current of CNT FET

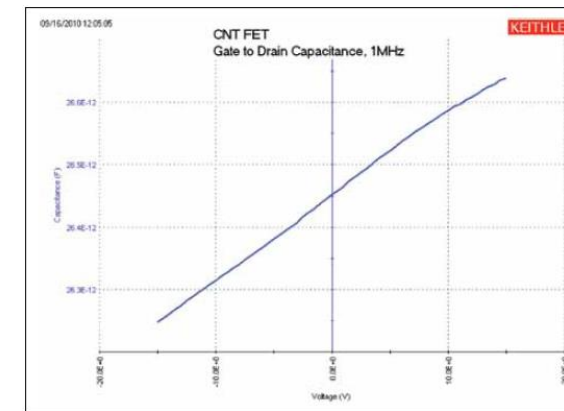
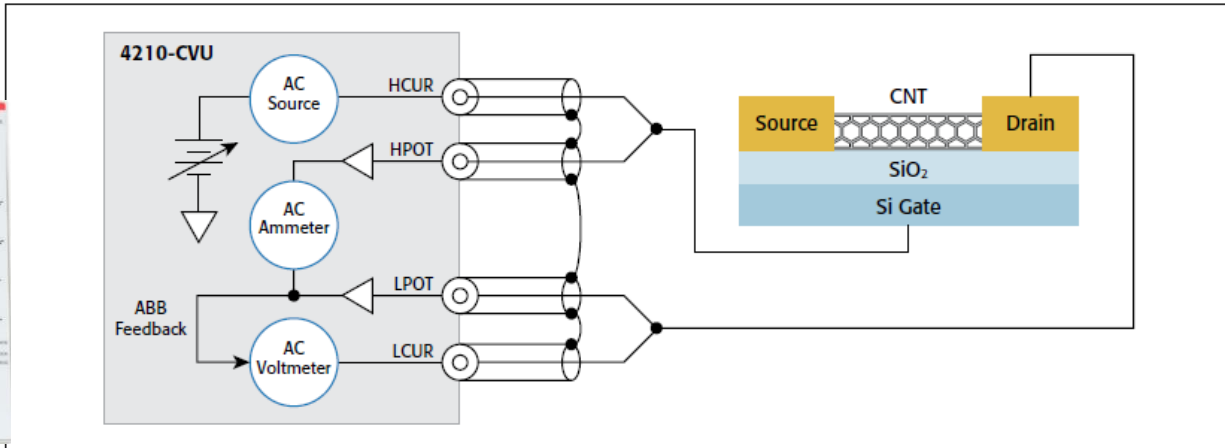

C-V sweep of gate-to-drain capacitance

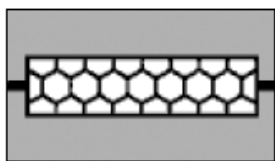

Carbon Nanotube



BioComponent

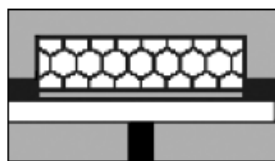

Carbon Nanotube FET



Nanowire

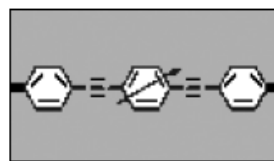

Molecular Wire



Molecular Transistor

Clarius中如何调用纳米器件测试的项目?

The screenshot displays the Clarius software interface. At the top, a workflow is shown with three steps: **Select** (represented by a list icon with a plus sign), **Configure** (represented by gear icons), and **Analyze** (represented by a graph icon). To the right of this workflow are three control buttons: **Run** (a play button), **Stop** (a square button), and **Save** (a floppy disk icon).

The main interface is divided into two panels. The left panel is a file explorer showing a folder named **nanodevices_1** containing several sub-items, each with a checkmark to its right:

- cnt
- nanowire
- molecular-wire
- biocomp
- cntfet
- molecular-transistor
- 6terminal-nanocell

The right panel is titled **Projects** and shows a **Project Library (2)**. It includes a **Sort By:** dropdown menu set to **Name: A to Z**, a search input field containing the text **nano**, and **Search** and **Clear** buttons. There are also checkboxes for **Image** and **Description**, both of which are checked. Below the search bar, two project entries are listed:

- Carbon Nanotube Transistor Characterization Project (cntfet-characterization)**
Includes tests for DC I-V, pulsed I-V, and C-V measurements on a carbon nanotube (CNT) FET.
- Nano Device Examples Project (nanodevices)**
Contains several I-V tests for common nano devices.



Select



Configure



Analyze



Run



Stop



Save



Copy



Cut



Paste



Rename



Delete

nanodevices

cnt

nanowire

lowr-sweep

lowr-didv

highr-sweep

highr-didv

molecular-wire

voltage-sweep

biocomp

cntfet

molecular-transistor

6terminal-nanocell

highr-didv#1

View:



Save Data

Run1 Formulas List

DIDV= DIFF(CURRENT,VOLTAGE)

Edit

	A	B	C	D
1	Current	Voltage	RESISTANCE	DIDV
2	-9.9287E-9	-10.0000E+0	1.0030E+9	#REF
3	-9.8243E-9	-9.9000E+0		1.0436E-9
4	-9.7222E-9	-9.8000E+0		1.0210E-9
5	-9.6230E-9	-9.7000E+0		992.5445E-12
6	-9.5271E-9	-9.6000E+0		958.8918E-12
7	-9.4291E-9	-9.5000E+0		980.2344E-12
8	-9.3286E-9	-9.4000E+0		1.0048E-9
9	-9.2300E-9	-9.3000E+0		985.2886E-12
10	-9.1286E-9	-9.2000E+0		1.0141E-9
11	-9.0314E-9	-9.1000E+0		972.6498E-12
12	-8.9318E-9	-9.0000E+0		995.7686E-12
13	-8.8333E-9	-8.9000E+0		984.5154E-12
14	-8.7344E-9	-8.8000E+0		989.7828E-12

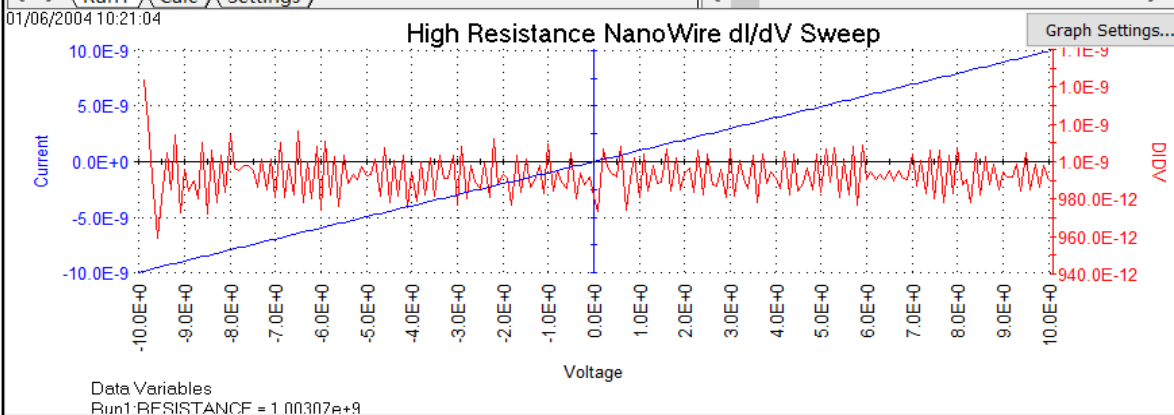



Select



Configure



Analyze



Run



Stop



Save



Copy



Cut



Paste



Rename



Delete

cntfet-characterization_1

cntfet



cntfet-vds-id



cntfet-vgs-id



cntfet-cvsweep



pulsed-vds-id



cnt-pulse



cntfet-cvsweep#1

View:



Save Data

Run1 Formulas List

Edit

	A	B	C	D	E
1	Cp_GD	Gp_GD	DCV_GD	F_GD	CVUIS
2	26.2482E-12	5.6324E-6	-15.0000E+0	1.0000E+6	00000001
3	26.2545E-12	5.6859E-6	-14.5000E+0	1.0000E+6	00000001
4	26.2610E-12	5.4406E-6	-14.0000E+0	1.0000E+6	00000001
5	26.2674E-12	5.2164E-6	-13.5000E+0	1.0000E+6	00000001
6	26.2748E-12	5.1206E-6	-13.0000E+0	1.0000E+6	00000001
7	26.2824E-12	5.1169E-6	-12.5000E+0	1.0000E+6	00000001
8	26.2891E-12	4.6489E-6	-12.0000E+0	1.0000E+6	00000001
9	26.2950E-12	4.5707E-6	-11.5000E+0	1.0000E+6	00000001
10	26.3006E-12	4.2871E-6	-11.0000E+0	1.0000E+6	00000001
11	26.3081E-12	4.3940E-6	-10.5000E+0	1.0000E+6	00000001
12	26.3142E-12	4.1997E-6	-10.0000E+0	1.0000E+6	00000001
13	26.3218E-12	3.9998E-6	-9.5000E+0	1.0000E+6	00000001

Run1 Calc Settings

09/16/2010 12:05:05

CNT FET
Gate to Drain Capacitance, 1MHz

Graph Settings...

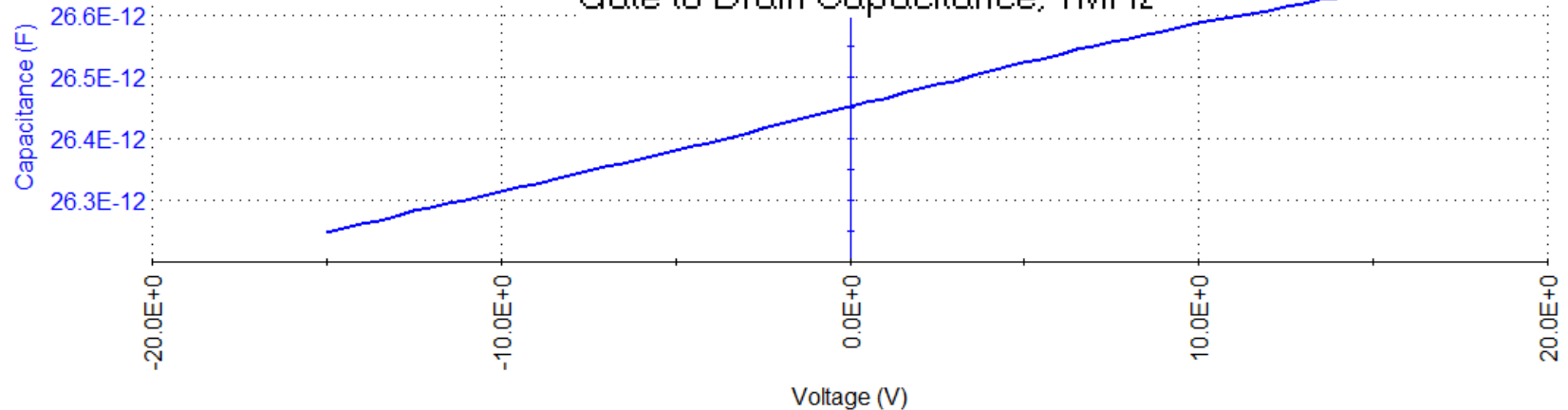

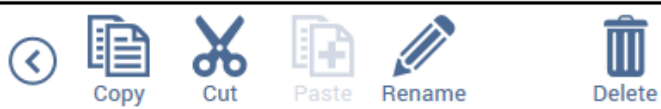

cntfet-vgs-id#1

View: Save Data Edit

cntfet-characterization_1

Run1 Formulas List

- cntfet
- cntfet-vds-id
- cntfet-vgs-id
- cntfet-cvswEEP
- pulsed-vds-id
- cnt-pulse

	A	B
1	GateV	DrainI
2	10.0000E+0	49.2659E-9
3	9.5000E+0	20.1254E-9
4	9.0000E+0	4.6604E-9
5	8.5000E+0	732.2932E-12
6	8.0000E+0	6.7394E-9
7	7.5000E+0	51.7978E-9
8	7.0000E+0	172.1960E-9
9	6.5000E+0	285.5392E-9
10	6.0000E+0	460.5267E-9
11	5.5000E+0	626.6217E-9
12	5.0000E+0	738.9124E-9
13	4.5000E+0	724.9202E-9

< > Run1 Calc Settings

09/13/2010 13:42:00

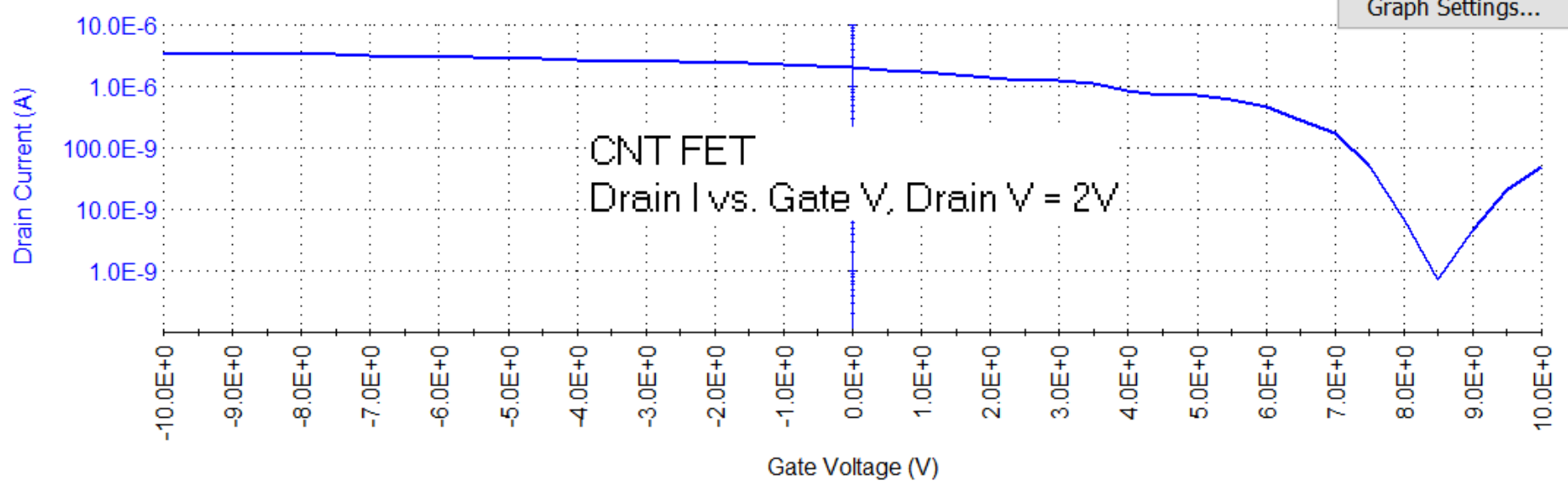

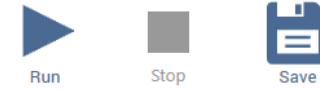

- cntfet-characterization_1
- Site 1 of 1
- Subsite
 - cntfet
 - cntfet-vds-id
 - cntfet-vgs-id
 - cntfet-cvsweep
 - pulsed-vds-id
 - cnt-pulse

Subsite Stress Properties

Device Stress Properties - Subsite: Subsite Device: cntfet Site #1

Stress Type

DC Voltage Stress
 DC Current Stress
 AC Voltage Stress

Stress Conditions

Active Site:

*NOTE: A 0 in the V Stress field means the Ground unit may b

North Stress <input type="text"/>	V	Gate Stress <input type="text" value="0"/>	V	NW Stress <input type="text"/>	V
North Limit <input type="text"/>	A	Gate Limit <input type="text" value="0.1"/>	A	NW Limit <input type="text"/>	A
Source Stress <input type="text" value="0"/>	V	Drain Stress <input type="text" value="0"/>	V	SW Stress <input type="text"/>	V
Source Limit <input type="text" value="0.1"/>	A	Drain Limit <input type="text" value="0.1"/>	A	SW Limit <input type="text"/>	A

Device Pin / Switch Connections

	VPU	On	Off		VPU	On	Off
North Pin <input type="text"/>	<input type="checkbox"/>	<input type="checkbox"/>	<input type="checkbox"/>	Northwest Pin <input type="text"/>	<input type="checkbox"/>	<input type="checkbox"/>	<input type="checkbox"/>
Source Pin <input type="text" value="0"/>	<input type="checkbox"/>	<input type="checkbox" value="2"/>	<input type="checkbox" value="2"/>	Southwest Pin <input type="text"/>	<input type="checkbox"/>	<input type="checkbox"/>	<input type="checkbox"/>
Gate Pin: <input type="text" value="0"/>	<input type="checkbox"/>	<input type="checkbox" value="3"/>	<input type="checkbox" value="3"/>	Southeast Pin <input type="text"/>	<input type="checkbox"/>	<input type="checkbox"/>	<input type="checkbox"/>
Drain Pin <input type="text" value="0"/>	<input type="checkbox"/>	<input type="checkbox" value="4"/>	<input type="checkbox" value="4"/>	Northeast Pin <input type="text"/>	<input type="checkbox"/>	<input type="checkbox"/>	<input type="checkbox"/>

Parameter Properties/Degradation Targets

Tests	Output Value

Stress Measurements

Range	Range

Stress Mode Setup Help

Enable Stress/Measure/Cycles

Stress/Measure Mode

Linear
 Log
 List

Stress Times

First Stress Time

Last Stress Time

Number of Stresses

Stress/Measure Delay

Stress Time

Enable Periodic Testing

Rate (s)

Segment Stress/Measure Mode

Cycle Mode



互动答疑环节

加入“泰克半导体直播讨论群”
只要你问，只要我有



开发未来 示波器的无限潜能

不同行业100种应用功能免费试用





抢答有奖

规则:

将三个问题的答案按照顺序一次性输入聊天框, 如: B A C

前五位回答正确的用户获得精美**星巴克礼券**一份,

礼品发放:

直播结束后, 小K会主动联系获奖用户发放礼券。



抢答有奖

规则：将三个问题的答案按照顺序一次性输入聊天框，
如：B A C **前五位回答正确**的用户获得精美**星巴克礼券**一份，

1. 纳米材料的超小电流一般到多少？

- A. μA
- B. nA
- C. pA
- D. fA

2. 对于以上超小电流选用什么仪器可测到？

- A. 4200-SMU
- B. 4200-SMU加PA
- C. 6430
- D. 6221

3. 一维纳米材料的典型代表是什么？

- A. 碳纳米管
- B. 石墨烯
- C. 二极管
- D. 晶体管



抢答有奖

1. 纳米材料的超小电流一般到多少？

- A. μA
- B. nA
- C. pA
- D. fA

2. 对于以上超小电流选用什么仪器可测到？

- A. 4200-SMU
- B. 4200-SMU加PA
- C. 6430
- D. 6221

规则： 将三个问题的答案按照顺序一次性输入聊天框，
如：B A C **前五位回答正确**的用户获得精美**星巴克礼券**一份，

3. 一维纳米材料的典型代表是什么？

- A. 碳纳米管
- B. 石墨烯
- C. 二极管
- D. 晶体管

答案公布： D B A



半导体材料与器件科学云讲堂

- ✓ 专业测试平台
- ✓ 六大类测试流程
- ✓ 剖析、解决半导体新问题



关注“泰克科技”公众号



每月2期专题直播，等您解锁！

直播日程

第一季 直播课程 (4~6月)

- 纳米材料及纳米电子器件IV和CV测试 4月29日
- 二维材料/石墨烯及其电子器件IV和CV测试 5月15日
- 量子材料及超导材料电输运物性表征测试 5月29日
- 超快脉冲在先进的NVM测试中的应用及神经元网络测试前瞻 6月

番外篇一

测试技巧: 半导体参数测试仪使用技巧及案例集锦 6月

第二季 直播课程 (7~9月)

- 宽禁带半导体(GaN/SiC)材料及器件测试
- 功率IGBT器件测试系统及自动化简介
- 微机电系统MEMS测试概述
- MOSFET的准静态CV/超低频CV测试
- 半导体器件可靠性HCI/NBTI测试

番外篇二

测试技巧: 快速上手自动化半导体参数测试系统

